



**BALTIMORE  
AIRCOIL COMPANY**



## **TSU-M ICE CHILLER® Thermal Storage Unit for internal melt**

### **OPERATING AND MAINTENANCE INSTRUCTIONS**





# Recommended maintenance and monitoring programme

Baltimore Aircoil Company's Ice Chiller<sup>®</sup> Thermal Storage Units and Thermal Storage Coils have been developed for long, trouble-free service when installed, operated and maintained properly. To ensure optimal performance and maximum equipment life for your Ice Chiller<sup>®</sup> Thermal Storage Unit, it is important that a regular inspection/maintenance program be developed and implemented. This manual is provided as a guide to unit operation and establishing an effective maintenance program for Ice Thermal Storage systems. Included in the manual are start-up and shutdown procedures, maintenance procedures and a schedule of maintenance items and their recommended frequency for the Ice Chiller<sup>®</sup> Thermal Storage Unit and its related components. An illustration of the Thermal Storage Unit, with its major components identified, is provided in "Ice Chiller<sup>®</sup>" on page 4 All inspections, maintenance and monitoring actions should be recorded in a cooling system logbook.

As part of your maintenance record, it is advisable to have a copy of the unit's certified drawing available for reference during inspection and maintenance. If you do not have a copy of this drawing, or need further information about the unit, contact your local BAC Service provider. You can find name, e-mail and phone number on the website [www.BACService.eu](http://www.BACService.eu).

Checks and adjustments	Start-Up	Monthly	Quarterly	Every 6 months	Annually	Shutdown
Operating level	X	X				
System charging	X					

Inspections and monitoring	Start-Up	Monthly	Quarterly	Every 6 months	Annually	Shutdown
General condition	X	X				
Ice Chiller <sup>®</sup> tank	X		X			
Ice Chiller <sup>®</sup> water <sup>(1)</sup>						
- Quality	X			X		
- Level	X	X				
Ice thickness	X	X				
Coil	X			X		
Ice Logic <sup>™</sup> Ice Quantity controller:						
- condition of sensor	X	X				
Refrigerant:						
- Glycol quality				X		

Cleaning procedures	Start-Up	Monthly	Quarterly	Every 6 months	Annually	Shutdown
Disinfection	X				X	X

## Notes

1. Water treatment and auxiliary equipment integrated in the cooling system may require additions to the table above. Contact suppliers for recommended actions and their required frequency.
2. Recommended service intervals are for typical installations. Different environmental conditions may dictate more frequent servicing.
3. When operating in ambient temperatures below freezing, the installation should be inspected more frequently.

# Table of contents

## OPERATING AND MAINTENANCE INSTRUCTIONS



<b>1</b>	<b>Construction details</b>	<b>4</b>
	Ice Chiller®	4
<b>1</b>	<b>General information</b>	<b>5</b>
	Operating conditions	5
	Connecting pipework	5
	Safety precautions	6
	Disposal requirements	7
	Non-walking surfaces	7
	Modifications by others	7
	Warranty	7
<b>2</b>	<b>Operating instructions</b>	<b>8</b>
	General Information	8
	Start-up and commissioning procedures	8
	Daily Operating Guidelines	10
	Seasonal Shutdown	10
	Ice Logic™ Ice Quantity Controller	11
<b>3</b>	<b>Water Care</b>	<b>21</b>
	About water care	21
	Passivation	21
	Special water treatment considerations	22
<b>4</b>	<b>Cold Weather Operations</b>	<b>23</b>
	About cold weather operation	23
	Protection of operating control assembly	23
	Insulation of piping	23
	Protection against coil freezing	23
	Ice due to subfreezing ambients	24
<b>5</b>	<b>Maintenance Procedure</b>	<b>25</b>
	General	25
	Checks and adjustments	25
	Inspections and corrective actions	27
<b>6</b>	<b>Comprehensive Maintenance</b>	<b>29</b>
	About comprehensive maintenance	29
	Prolonged outdoor stay	29
<b>7</b>	<b>Further Assistance &amp; Information</b>	<b>30</b>
	Assistance	30
	More information	30

# TSU-M CONSTRUCTION DETAILS

## Ice Chiller®

### INTERNAL MELT APPLICATION

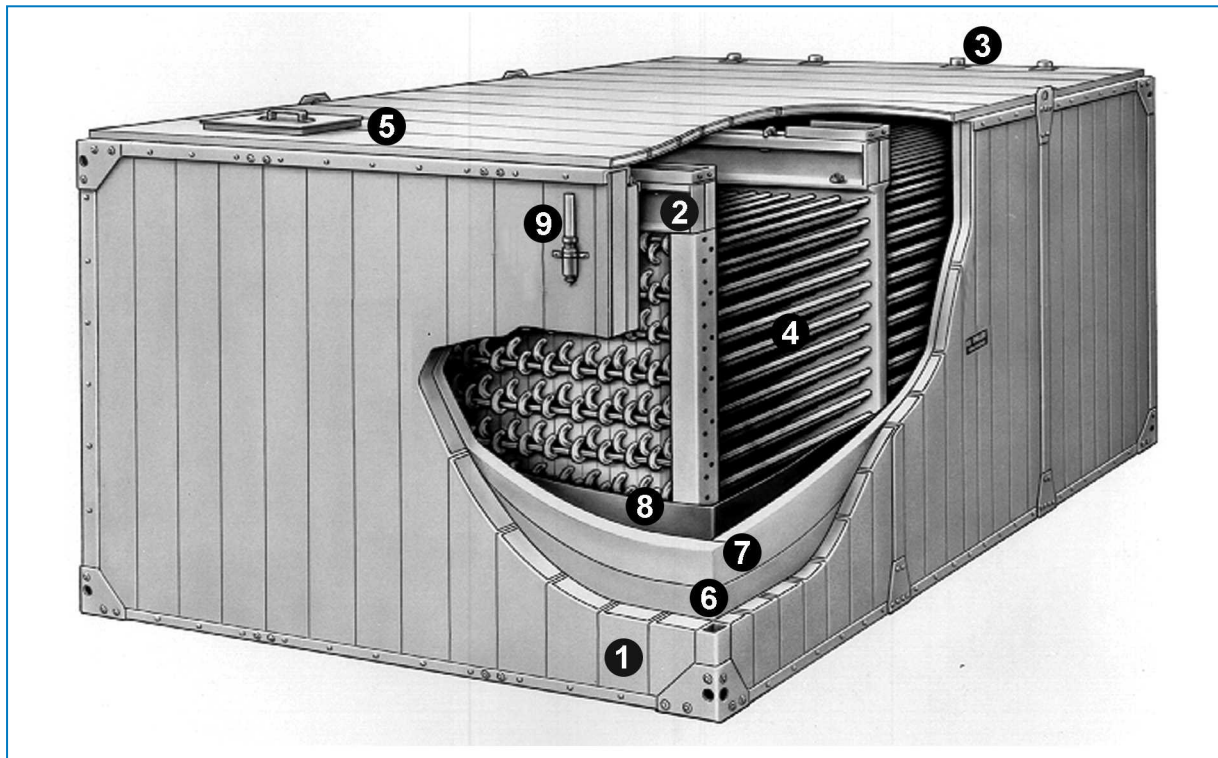

1. Wall panel
2. Coil support beams
3. Glycol connections
4. Galvanised steel coil
5. Watertight covers
6. Primary liner
7. Extruded polystyrene insulation
8. Secondary liner/Vapor barrier
9. Sight tube

Not shown: Ice Inventory Sensor - Ice Logic™ Ice Quantity Controller – Air pump



# TSU-M GENERAL INFORMATION

## Operating conditions

BAC cooling equipment is designed for the operating conditions specified below, which must not be exceeded during operation.

- **Wind Load:** For safe operation of unshielded equipment exposed to wind speeds above 120 km/h installed at a height above 30 m from the ground, contact your local BAC representative.
- **Seismic Risk:** For safe operation of equipment installed in moderate and high hazard area's contact your local BAC representative.

## ICE THERMAL STORAGE UNIT

1. For units designed to work with secondary coolants:
  - Fluid compatibility: Fluids circulated through the coil(s) must be compatible with the coil construction material. Standard coils are constructed of black steel.
  - Coil design pressure: max. 10 bar
  - Max. temperature of fluid: +50°C
  - Min. temperature of fluid: -20°C
- The coils are manufactured from black steel and hot dip galvanised after fabrication and may contain certain contaminants, such as carbon, iron oxide or welding particles.
- The installer must take the necessary precautions on site to safeguard the operation of sensitive components in conjunction with the coils.

## PURGE REQUIREMENTS

The installer of BAC equipment must ensure proper system purging of air prior to operation. Entrained air can obstruct the proper flow of glycol solution, resulting in higher operating pressures than design and reduced thermal storage capacity.

## Connecting pipework

All piping external to BAC cooling equipment must be supported separately.

In case the equipment is installed on vibration rails or springs, the piping must contain compensators to eliminate vibrations carried through the external pipework.

All connections in the external pipework (installed by others) must be leak free and tested accordingly.



## Safety precautions

All electrical, mechanical and rotating machinery constitutes a potential hazard, particularly for those not familiar with its design, construction and operation. Accordingly, adequate safeguards (including use of protective enclosures where necessary) should be taken with this equipment both to safeguard the public (including minors) from injury and to prevent damage to the equipment, its associated system and the premises.

If there is doubt about safe and proper rigging, installation, operation or maintenance procedures, contact the equipment manufacturer or his representative for advice.

When working on operating equipment, be aware that some parts may have an elevated temperature. Any operations on elevated level have to be executed with extra care to prevent accidents.

### AUTHORIZED PERSONNEL

The operation, maintenance and repair of this equipment should be undertaken only by personnel authorized and qualified to do so. All such personnel should be thoroughly familiar with the equipment, the associated systems and controls and the procedures set forth in this and other relevant manuals. Proper care, personal protective equipment, procedures and tools must be used in handling, lifting, installing, operating, maintaining and repairing this equipment to prevent personal injury and/or property damage. Personnel must use personal protective equipment where necessary (gloves, ear plugs, etc...)

### MECHANICAL SAFETY

Mechanical safety of the equipment is in accordance with the requirements of the EU machinery directive. Depending upon site conditions it also may be necessary to install items such as bottom screens, ladders, safety cages, stairways, access platforms, handrails and toe boards for the safety and convenience of the authorized service and maintenance personnel.

At no time this equipment should be operated without all access cover panels and access doors in place/closed and properly secured.

For more information consult your local BAC representative.

### ELECTRICAL SAFETY

All electrical components associated with this equipment should be installed with a lockable disconnect switch located within sight of the equipment.

In the event of multiple components, these can be installed after a single disconnect switch but multiple switches or a combination thereof are also allowed.

No service work should be performed on or near electrical components unless adequate safety measures are taken. These include, but are not limited to the following:

- Isolate the component electrically
- Lock the isolation switch in order to prevent unintentional restart
- Measure that no electrical voltage is present anymore
- If parts of the installation remain energized, make sure to properly demarcate these in order to avoid confusion

Fan motor terminals and connections may have residual voltage after unit shut-down. Wait five minutes after disconnecting the voltage at all poles before opening the fan motor terminal box.

### LOCAL REGULATIONS

Installation and operation of cooling equipment may be subject to local regulations, such as establishment of risk analysis. Ensure regulatory requirements are consistently met.

## Disposal requirements

Dismantling of the unit and treatment of refrigerants (if applicable), oil and other parts must be done with respect to the environment whilst protecting workers from potential risks related to exposure to harmful substances. National and regional legislation for material disposal and protection of workers should be taken into account with regard to:

- Appropriate handling of construction and maintenance materials when dismantling the unit. In particular when dealing with materials that contain harmful substances, such as asbestos or carcinogenic substances.
- Appropriate disposal of the construction and maintenance materials and components such as steel, plastics, refrigerants and waste water according to local and national requirements for waste management, recycling and disposal.

## Non-walking surfaces

Access to and maintenance of any component needs to be performed in accordance with all local applicable laws and regulations. If the proper and required access means are not present, temporary structures need to be foreseen. Under no circumstance can one use parts of the unit, that are not designed as an access mean, unless measures can be taken to mitigate any risks that might occur from doing so.

## Modifications by others

Whenever modifications or changes are made by others to the BAC equipment without written permission of BAC, the party who has done the modification becomes responsible for all consequences of this change and BAC declines all liability for the product.

## Warranty

BAC will guarantee all products to be free from manufactured defects in materials and workmanship for a period of 24 months from the date of shipment. In the event of any such defect, BAC will repair or provide a replacement. For more details, please refer to the Limitation of Warranties applicable to and in effect at the time of the sale/purchase of these products. You can find these terms and conditions on the reverse side of your order acknowledgement form and your invoice.

## General Information

To ensure dependable, trouble-free, efficient operation of the thermal storage units, each system is provided with factory installed, operating control assemblies. During normal operation a solid layer of ice at the top of the tank will not form. However, should such a layer form due to unforeseen and unwanted operational circumstances, the low level alarm can be activated. In such case melt out the ice completely.

## Start-up and commissioning procedures

For internal melt applications, the ice quantity is measured by measuring the difference in water level in the tank that occurs due to ice build-up. Ice has a lower density than water, and therefore the water level increase will be proportioned to the ice quantity inside the tank.

The Analogue Ice Thickness Transmitter is factory installed on the tank and consists of two major components:

- Transmitter box, for power supply and passive analogue 4-20 mA output signal.
- A guided wave radar sensor installed in a PVC tube.

In case the sensor is exposed to subfreezing temperatures (outside installation), the sensor and connected PVC piping must be heat traced.

### TANK FILLING AND ICE LOGIC CALIBRATION

The sensor is factory mounted and wired to the transmitter box, which is located at the connection end of the tank.

A “zero level” adjustment (=calibration) is needed at start-up. To follow the procedure for the correct calibration, please refer to chapter: “Ice Logic™ Ice Quantity Controller”.

Make sure there is no ice left in the tank. Fill the ice thermal storage unit according to following instructions:

1. Open the ball valve so that the water can enter the water level sensor. The water level in the sight tube must be below the 0% level.
2. Use a hose through the hatch opening to fill the tank to the top of the coil. Water level must remain below 0% level indicated on the label.





Ice Logic™ with radar sensor



**CAUTION**

**Do not overflow!**

**Overflowing the tank may damage the insulation and/or cause the operating controls to malfunction.**

3. Continue to fill the tank slowly with a minimum of water turbulence until the water level in the sight tube corresponds with the zero water level indicated on the label.



**CAUTION**

**Make sure no more water is added to the tank.**

4. If necessary, move the sensor upwards until the water level (0% ice) falls between the minimum and maximum calibration lines indicated on the sensor tube.



## SYSTEM CHECKS

Before initiating the first ice build cycle, check the following points:

1. Verify the system has been charged with a glycol solution of the type and concentration specified.
2. Confirm all circulating pumps are rotating in the proper direction.
3. Confirm there is sufficient load to discharge the tanks.
4. If any of the units are equipped with a heated enclosure around the operating control and sight tube, check to ensure the heater and thermostat are wired and operational.

Once the checks are completed, start the initial ice build cycle and monitor the system throughout the cycle, recording glycol temperatures and noting the duration of the build. Confirm the operating controls function properly to terminate the build cycle and that once the build cycle is completed, the chiller is shut down and locked out until the cooling cycle is initiated.

On multiple unit installations, once the initial ice build cycle has been completed, check all the sight tubes to verify the water levels in each tank are equal. If the inventories are significantly out of balance, the flow rates of the glycol solution to each of the thermal storage units should be checked and balanced. Then, after the next ice build cycle, check the sight tubes once again to ensure balance has been achieved.

## Daily Operating Guidelines

### BUILD CYCLE

For the most energy-efficient operation of the system, the controls should be designed to operate the build cycle as follows:

Once the ice build cycle has been initiated, the glycol chiller(s) should run at full capacity without cycling or unloading until the storage device is fully charged (recharged). At that point, the chiller and the glycol circulating pump should be turned off and not allowed to restart until the discharge (cooling) cycle is initiated. Additionally, a build cycle should not be re-initiated until approximately 15% of the ice has been melted.

### DISCHARGE (COOLING) CYCLE

Ice Chiller® Thermal Storage units can be discharged in a variety of ways depending upon the system configuration and objectives of the system designer. Consult the project drawings and specifications for direction on how the system is to operate during the discharge (cooling) cycle.

It is recommended to completely melt-out the ice during each cooling cycle by pumping the warm glycol solution through the coils. If complete melt-out cannot be accomplished, try to melt out as much ice as possible.



#### CAUTION

**Unmelted ice is wasted energy.**

## Seasonal Shutdown

Ice Chiller® Thermal Storage Units installed indoors in a heated space (or outdoors where subfreezing temperatures do not occur) do not require special attention or preparation for a seasonal or winter shutdown. However, if subfreezing conditions do occur, please refer to section "About cold weather operation" on page 23

# Ice Logic™ Ice Quantity Controller



## ANALOGUE ICE THICKNESS TRANSMITTER AITT-420-R (RADAR TYPE SENSOR)

When ice is build the water level will increase in the tank. The water level rise is proportional to the % of ice present in the tank. The radar type Ice Logic measures the water level by the principle of guided wave radar. It measures the level using electromagnetic pulses. The pulses are transmitted by the sensor head and guided along a rod. When they hit the medium to be detected (in our case water), they are reflected and guided back to the sensor. The time between transmitting and receiving the pulse directly relates to the travelled distance and the current level.

The sensor has no moving parts, is not sensitive to pollution and is independent of the fluid properties.

Prior to setting the controller, make sure the ice tank is filled with water and the radar type sensor in connected to the control box according to the wiring diagram below and the 230V supply voltage is present. The zero level markings on the sensor should correspond with the zero level (water without ice) in the tank.

When properly set, the control box will provide a passive 4-20 mA output signal where 0 mA stands for 0% ice and 20mA corresponds with 100% ice (full ice build).

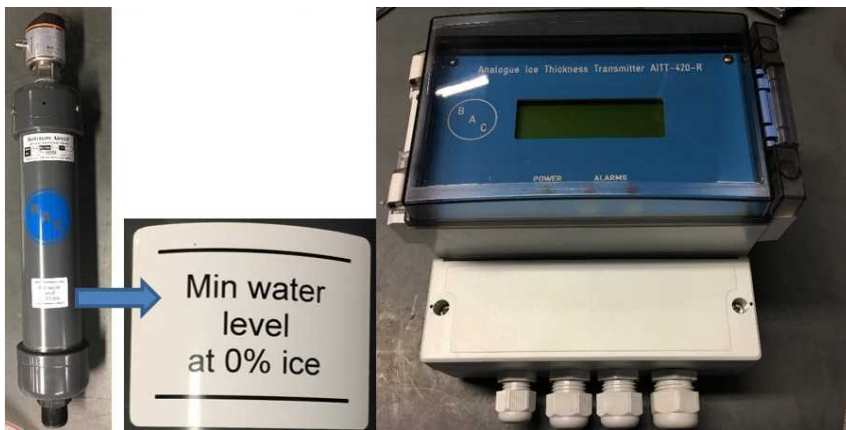

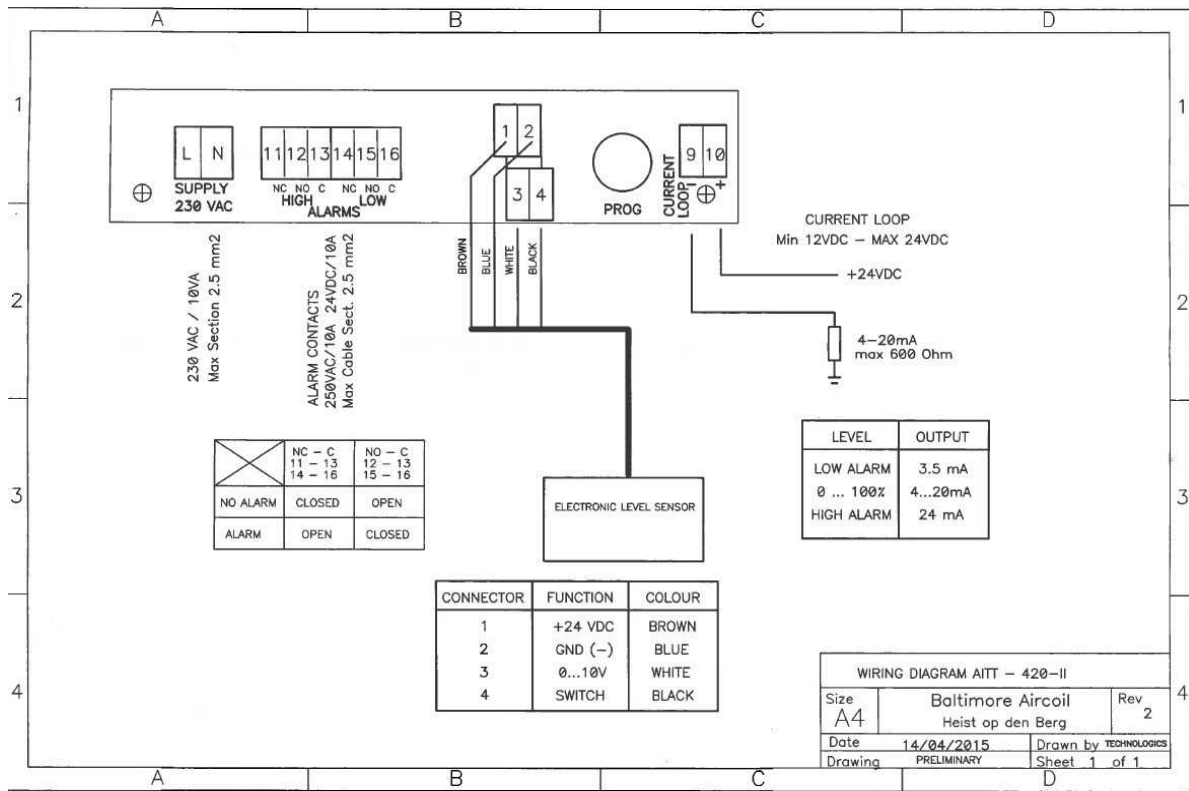

## WIRING SPECIFICATION

Terminal	Fuse Description
LN	L-N220VAC / max 10VA supply Max. cable section is 2.5 mm <sup>2</sup>
1, 2, 3, 4	Sensor terminals (Wiring done by BAC). Wiring details see wiring diagram.
9, 10	4-20mA passive current loop output. External voltage: max. 24VDC / %o, 12VDC Max. loop resistance at 24VDC: 600 Ohm. Max. cable section 1.5 mm <sup>2</sup> 9 = negative, 10 = Positive
11, 12, 13	High level alarm contacts. 380VAC/10A - 24VDC/10A Max. cable section is 2.5 mm <sup>2</sup> - 11, 13 = normally closed (NC) - 12, 13 = normally open (NO)
14, 15, 16	Low level alarm contacts. 380VAC/10A - 24VDC/10A Mac cable section is 2.5mm <sup>2</sup> - 14, 16 = normally closed (NC) - 15, 16 = normally open (NO)

Wiring specification

## OUTPUT SIGNAL GRAPHICS

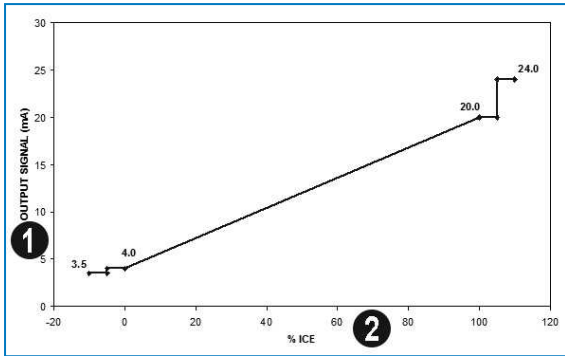

Output signal graphic

1. Output signal (mA)
2. % Ice

## START UP

At initial start up the range of the water level rise must be entered into the controller and the zero ice (water) level must be set. Make sure no ice is present in the tank and the water level is at zero level from the sight glass. Put the power supply at least 15 minutes on prior to commissioning of the controller to allow the radar sensor to warm up.



### CAUTION

**Never operate the black control knob whenever the protective cover above the supply terminals is not properly installed.**

At initial start up the following screen is shown:

```

*** Set up Error ****
  Range Not Valid !
  Set range
  Press to continue
  
```



In the terminal box of the controller, you can find a black knob. Pressing this knob or button results in activating a menu, a selected line or confirming your choice. Rotating the button allow to change values (dial) or navigate through the menu. The active line has a ">" mark in front of it.

Press the black button to continue. Following screen appears:

Adjust  
Range !  
  
117 mm

For standard TSU-M models the range setting is 117 mm. For TSU-ML models (low height) the standard setting is 92 mm. Dial the correct setting for the model at hand (check the unit name plate) by rotating the black knob. Confirm your selection by pressing the black knob. The next screen appears:

Range  
will be changed !  
Dial '7' and press ...  
0

Rotate the black button to dial 7 and press to confirm. The display indicates 'Range successfully changed'. In case the button is pressed without dialing 7 you return to the previous menu and values are not stored. After the range is entered, the following screen appears for a few seconds, followed by the next screen:

Initializing  
Connecting sensor  
  
████████████████████

\*\*\* Set Up Error \*\*\*\*  
Zero Level Not Valid !  
Set Zero Level  
Press to continue..

Now follow the procedure to set the zero level. When pressing the black button you enter the screen below. Rotate the black button to select 'Set Zero Level' and press to activate. Make sure you only do this when no ice is present in the ice tank and when the water level is at the zero level of the sight glass. (For concrete tank applications make sure the water level is just above the coil header.)

Quit  
Set Zero Level  
Set Update Period  
Show Range

Select 'Set Zero Level' by rotating the black button and press to confirm.

Set current level  
as zero level?  
  
No

Rotate the black knob to change 'No' to 'Yes' and press to confirm your choice. When choosing 'No', you return to the previous menu. When pressing 'Yes' you access the screen below:

Acquiring  
zero level. !  
  
Sample : 1

The sample counter moves from 1 to 16 and then the next screen is shown:

Zero level  
will be changed !  
Dial '7' and press..  
0

Rotate the black knob to dial 7 and press to confirm the zero setting. The display shows 'Zero Level successfully changed' to confirm the setting. If the black button is pressed without dialing 7, the zero level is not stored.



In case the sensor is not in the correct position (sensor too high or too low) to allow a correct full range measurement, the display will indicate an error first and the position of the sensor must be modified after which the procedure must be repeated. Examples of possible alarm messages in case of false sensor position are shown below.

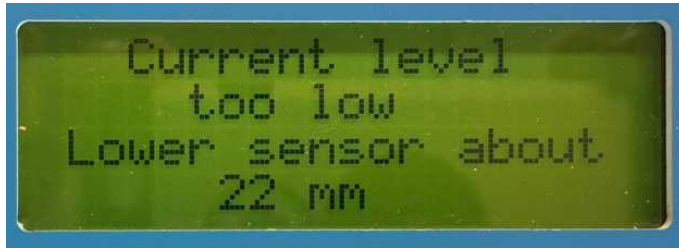

### START SCREEN / SCREEN AT NORMAL OPERATION

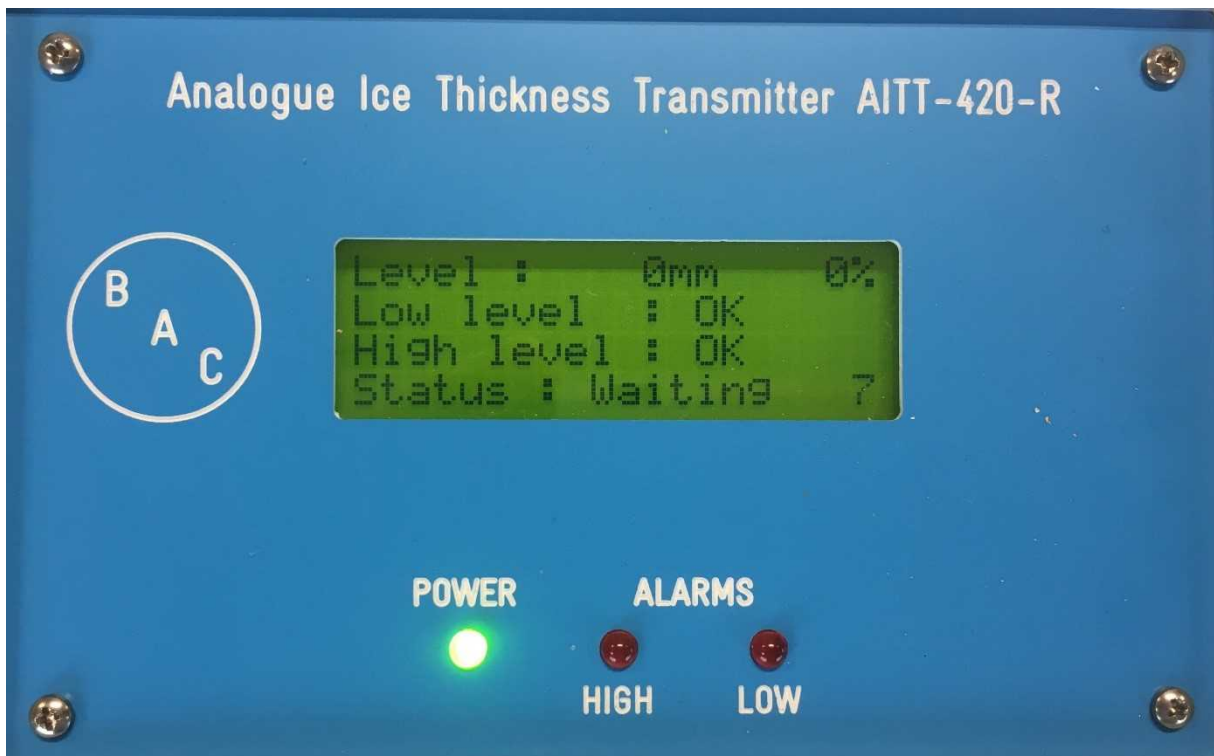



```

Level: 0mm   %
Low Level:  OK/Alarm
High Level:  OK/Alarm
Status: Waiting/Updating 7
  
```

The display shows the measured water level in mm and the percentage versus the range that was set to correspond with 100% ice.

On line 2 and 3 the status of the low and high level alarm is shown. 'OK' means there is no alarm. If the water level is below the minimum level, the Low Level Alarm is activated and 'Alarm' is displayed on the screen. The output contact for low alarm (13/14/15) is also activated and the red LED for low alarm lights up. The 4-20mA output signal is set at 3.5mA to indicate a low level alarm. If the water level rises above the maximum level, the High Level Alarm is activated and 'Alarm' is displayed on the screen. The output contact (11/12/13) for high alarm is also activated and the red LED for high alarm lights up. The 4-20mA output signal is set at 24mA to indicate a high level alarm.

The bottom line shows when the next measurement will be done (Waiting and counting down) or if the value is being updated (Updating) at the end of the count down.

### CONTROLLER SET UP MENU

By pressing the black button, you get in the following screen. On the screen you see 4 lines. You can scroll down by rotating the black button.

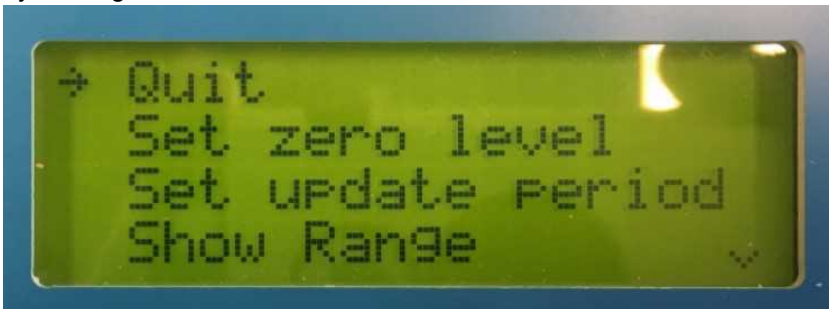

```

Quit
Set Zero Level
Set Update Period
Show Range
  
```

By scrolling down you can see following additional lines:

```

Set Range
Service Menu
Software Version
  
```

The '->' sign in front of the lines indicates which line is selected. The arrow up or down at the right of the screen indicates that more lines are available in the upper or lower area of the screen.



To select or activate a line, press the black button. If you want to navigate through the menu or change values or settings, rotate the black button to dial and press to confirm.

## DETAILS OF EACH LINE

### Quit

Activate to return to the previous menu.

### Set Zero Level

Activate to set the zero ice level value. Make sure you only do this when no ice is present in the ice tank and when the water level is at zero level of the sight glass. (For concrete tank applications make sure the water level is just above the coil header.)

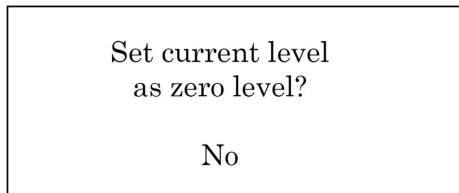

Rotate the black knob to change 'No' to 'Yes' and press to confirm your choice. When choosing 'No', you return to the previous menu. When pressing 'Yes' you access the screen below:

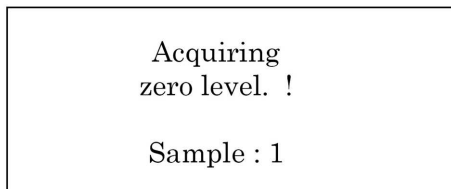

The sample counter moves from 1 to 16 and then the next screen is shown.

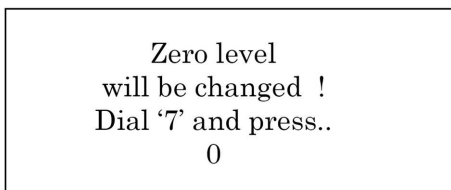

Rotate the black knob to dial 7 and press to confirm the zero setting. The display shows 'Zero Level successfully changed' to confirm the setting. If the black button is pressed without dialing 7, the zero level is not stored.



In case sensor position is no good to allow a full range measurement, an alarm message is shown on the display. Modify sensor position and start over.

### Set Update Period

This allows you to determine how often a measurement will be updated by the controller. Typically 120 seconds is set. During commissioning or testing periods the sample time can be reduced to obtain quicker response. Make sure to put this time long enough to get a stable output signal.

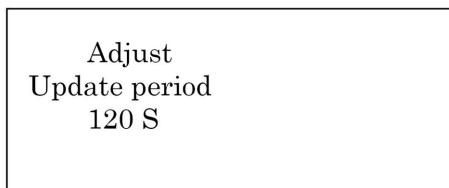

Rotate the black button to dial different value. Press button to confirm or leave the menu.

### Show Range

This allows you to see the range which corresponds to 100% ice level rise. For TSU-M models the range is typically 117 mm, for TSU-ML models this is typically 92 mm.

This menu is only to view the range. Setting the range is another menu (Set Range).

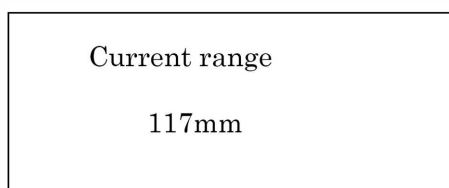

Press button to confirm or leave the menu.

### Set Range

This allows you to set the range which corresponds to 100% ice level rise. For TSU-Models this range is typically 117 mm, to TSU-ML models this is typically 92 mm. This menu can only be accessed after dialing the access code 2220 preventing unwanted change of settings. (During initial start up the access code is not asked for.)

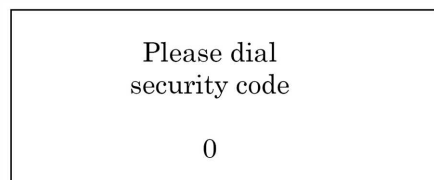

Rotate the black button to select 2, press to confirm. Press 2 more times to confirm next 2 digits. Dial then to select 0 and press to confirm. You have now entered access code 2220.

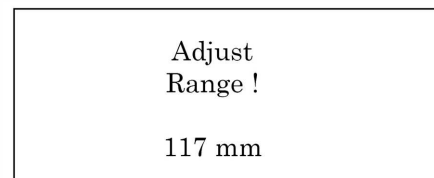



For standard TSU-M models the range setting is 117mm. For TSU-ML models (low height) the range setting is 92 mm. Dial the correct setting for the model at hand by rotating the black knob. Confirm your selection by pressing the black knob.

Range  
will be changed !  
Dial '7' and press ..  
0

Rotate the black button to dial 7 and press to confirm. The display indicates 'Range successfully changed'. In case the button is pressed without dialing 7, you return to the previous menu.

### Service Menu

This menu allows to do additional factory settings which are not accessible by the standard user. If you enter the menu you get the following screen. Keep pressing the black button to exit. You can only enter with the correct code.

Please dial  
security code  
0

### Software Version

Press black button to see which software version is installed on the controller.

Release: 1.1  
Date: 25/11/2017  
  
Technologies bvba

### About water care

In the near freezing temperatures of the Ice Chiller® Thermal Storage Unit, scale and corrosion are naturally minimized. Therefore, for the tank water side of the units, a water treatment program to prevent scale or corrosion is not normally needed, unless the water is corrosive in nature. To control biological growth, a biocide may be needed on a periodic basis to prevent the growth of corrosive bacteria. In general, BAC recommends the following guidelines. (See table below).

	Recommended tank water quality
pH	7.0 to 9.0 *
Hardness (as CaCO <sub>3</sub> )	90 to 500 mg/l
Alkalinity (as CaCO <sub>3</sub> )	500 mg/l max.
Total dissolved solids	1000 mg/l max.
Chlorides	125 mg/l max.
Sulfates	125 mg/l max.
Conductivity	100-700 µS/cm

#### Water quality guidelines

\* Tank water pH of 8.2 or higher will require periodic passivation of the galvanized steel coils to prevent "white rust", the accumulation of white, waxy, non-protective zinc corrosion products on galvanized steel surfaces.



#### CAUTION

**Do not treat the tank water with chemicals that alter the freeze point of water.**

### Passivation

When new systems are first commissioned, special measures should be taken to ensure that galvanized steel surfaces are properly passivated to provide maximum protection from corrosion. **Passivation** is the formation of a protective, passive, oxide layer on galvanized steel surfaces.



To ensure that galvanized steel surfaces are passivated, for the first 6-8 weeks of operation, the pH of the tank water should be maintained between 7.0 and 8.2 and calcium hardness maintained between 100 and 300 mg/l (as CaCO<sub>3</sub>). The passivation is complete and effective when the new zinc surfaces turn dull grey in colour. If white deposits form on galvanized steel surfaces after the pH is returned to normal, this is a sign of white rust, and therefore, the passivation process should be repeated to insure proper passivation and maximum corrosion resistance.

In case that your water quality does not allow the pH to remain below 8.2, then you should consult a water treatment specialist for advice on pH reduction or special passivation agents to promote proper passivation.

## Special water treatment considerations

### ICE TANK WATER

- Since ice tanks can be on and off during the course of the year, it is possible for microbiological growth to develop. Therefore, the best practice hygiene recommendation is for a dosage of non-oxidizing biocide once/year. If the unit is an external melt, the biocide should be added after the unit is brought down for cleaning and during the refill process, to insure proper mixing.
- Following passivation, if the tank water is corrosive in nature (low hardness, low pH or alkalinity), the addition of a corrosion 'non-precipitating' corrosion inhibitor is recommended. Examples of 'non-precipitating' corrosion inhibitors are nitrites, molybdates and silicate based blends. Care must be taken not to use corrosion inhibitors that raise the conductivity > 700 µS/cm, or alter the freezing point of the water. Therefore, such decisions need to be taken with the advice of a water treatment specialist. For example, if the ice water needs food grade approval because it could contaminant food products, then the silica based treatment programme is normally used, if it meets food grade regulations.

### GLYCOL SIDE OF THE ICE COIL

- Only use "inhibited" glycol that contains pH buffers. Never use industrial grade ethylene glycol. The reason for this recommendation is that over time, glycol degrades and produces "glycolic acid" as a result. These acids reduce the pH of the circulating water, and this will cause corrosion of steel materials of construction.
- As an added protection, the glycol loop should be treated with a nitrite, molybdate or silicate-based corrosion inhibitor to promote metal passivation, and provide additional alkalinity to raise the pH above 9.0. Always consult a water treatment specialist for recommendations on which corrosion inhibitor is most effective for your specific water quality



# TSU-M COLD WEATHER OPERATIONS

## About cold weather operation

BAC equipment can be operated in subfreezing ambient conditions provided the proper measures are taken:

1. Insulation of piping.
2. Protection against coil freezing.
3. Elimination of ice due to sub-freezing ambient.

Listed below are general guidelines which should be followed to minimize the possibility of freeze-up. As these guidelines may not include all aspects of the anticipated operation scheme, system designer and operator must thoroughly review the system, location of the equipment, controls and accessories to ensure reliable operation at all times.

When tanks are installed outdoors and exposed to subfreezing conditions, a minimum heat load must be applied to avoid solid ice formation inside the tank and prevent damage.

## Protection of operating control assembly

When the thermal storage unit will be exposed to subfreezing ambient temperatures, the Operating Control Assembly, the sight tube assembly and, if so equipped, the Ice Inventory Sensor must be protected.

The sight tube and optional inventory sensor must be heat traced and insulated. It is not necessary to drain the unit during cold weather.

## Insulation of piping

Precautions must be taken to protect the associated piping from freezing conditions. Heat tracing and insulation should be installed on all piping connected to the unit to prevent cracking.

## Protection against coil freezing

TSU Ice Thermal Storage coil(s) must be protected from damage by freezing of the fluid inside the coil(s) when in operation. Freeze protection must be obtained by the use of ethylene or propylene glycol or other anti-freeze solutions in appropriate concentrations.

TSU Ice Thermal Storage installations typically use a 25% (by weight) solution of industrially inhibited ethylene glycol for both corrosion and freeze protection. The systems lowest operating temperature should be at least 3°C to 4°C above the anti-freeze solution freeze point. Uninhibited ethylene glycol and automotive antifreeze solutions are NOT to be used in TSU Ice Thermal Storage coil(s).

The table below indicates the freeze protection range for various ethylene glycol concentrations (% by volume).

% Ethylene	Freeze protection
20%	-10°C
30%	-16°C
40%	-25°C
50%	-39°C

*Freeze protection of ethylene glycol solutions*



Glycol systems require specific inhibitors compatible with the materials of construction they come into contact with. These inhibitors generally come pre-mixed with the glycol additive for the cooling circuit.

## Ice due to subfreezing ambients

Ice Chiller<sup>®</sup> tanks that have been exposed to severe or sustained subfreezing ambient temperatures, should be checked before initiating an ice build cycle. Ice created by subfreezing ambient temperatures which accumulates at the top of the tank and around the walls must be melted out before initiating a build cycle. This ice can prevent normal water displacement during the build cycle, possibly leading to physical damage to the coil and tank walls.

Ice melt can be confirmed visually, but it is recommended the temperature of the water in the tank be raised to 4,4°C to ensure all ice is melted.



# 5

## TSU-M MAINTENANCE PROCEDURE

### General

A program of regular inspection and maintenance is essential for optimum performance and maximum service life. The following information is provided as a guide to establishing such a maintenance program. If you have any specific questions, please contact your local BAC service provider or representative whose name, e-mail and phone number can be found on the website [www.BACservice.eu](http://www.BACservice.eu).

The model type and serial number of your equipment appear on the nameplate at the connection end of the unit.

### Checks and adjustments

#### OPERATING LEVEL

Locate the tank access cover and the sight tube showing the tank water level (see figure below).

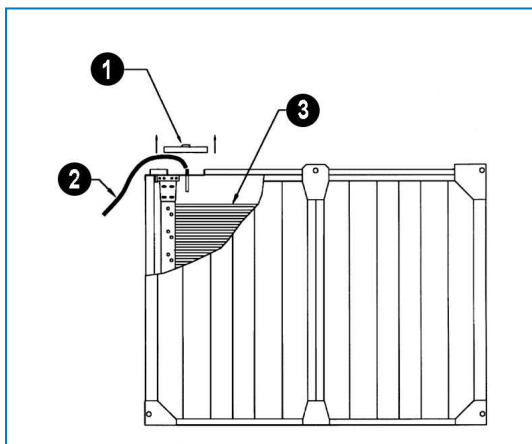

Side elevation - Location of tank fill connection

1. Access covers
2. Fill hose
3. Top of coil tubes

Using good quality water (see section "About water care" on page 21), fill the tank following the steps outlined below. For proper, long-term operation of the thermal storage unit, the tank must be filled exactly to the prescribed level.

1. Remove the access cover on the top of the unit. Use a fill hose to fill the tank. See following table "Fluid volumes" for the approximate volume of water required.

Model	Tank volume (liters of water)	Coil volume (liters of glycol solution)
TSU-237M	11320	985
TSU-476M	22110	1875
TSU-594M	28250	2320
TSU-761M	34640	2990
TSU-L184M	8820	770
TSU-L370M	17250	1460
TSU-L462M	22030	1810
TSU-L592M	27020	2280

*Fluid volumes*

- Continue filling the tank until the water level in the clear sight tube reaches the "0% ice build" level (See figure "Water level in sight tube").



**CAUTION**

For proper operation tank must be initially filled to the "0" ice build level.

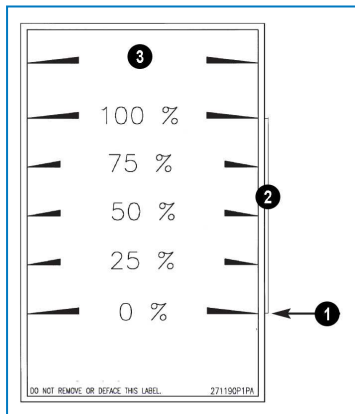

*Water level in sight tube*

- Fill initially to this level "0"
  - Percent ice build
  - Overflow
- When the tank is filled, remove the fill hose, then replace and tightly secure the access cover.



**CAUTION**

**Do not overfill!**

Overflowing the tank may damage the insulation and/or cause the operating controls furnished with the unit to malfunction.

## Inspections and corrective actions

### GENERAL CONDITION OF THE EQUIPMENT

The inspection should focus on following areas:

- damage of corrosion protection
- signs of scale formation or corrosion
- accumulation of dirt and debris
- presence of biofilms

Smaller damages of the corrosion protection **MUST** be repaired as soon as possible to prevent the damage from getting bigger.

If there is evidence of scale formation (more than 0,1 mm) or corrosion, water treatment regime must be checked and adjusted by the supplier.

If there is evidence of biofilms the system, including piping should be drained, flushed and cleaned of slimes and other organic contamination. Refill system with water and apply biocide shock treatment. Check pH value and functionality of ongoing biocide treatment.

On a monthly basis, inspect the frame and exterior panels, for signs of corrosion or any unusual conditions. If corrosion is found, wire brush the area and treat with a cold galvanizing, zinc rich compound (ZRC).

### ICE CHILLER® TANK

All Ice Chiller® Thermal Storage Units are provided with sectional insulated tank covers, which, when kept in place, will minimize the accumulation of trash or debris in the tank.

Quarterly, remove the access cover and inspect the interior of the unit for signs of scale formation, corrosion, or biological growth on the tube bundle. If present, initiate or modify the water treatment program (see section "About water care" on page 21).



Repeated freezing and thawing can cause some minerals dissolved in the water to precipitate. If observed, this is not a cause for concern.

### ICE CHILLER® WATER LEVEL

On a monthly basis and at seasonal start-up, inspect the water level in the tank. To properly check the water level in the tank, **the ice must be completely melted**.

At seasonal start up, and at least once a month thereafter during the operating season, conduct a full melt-out and continue to add heat to the tank until the water temperature is approximately 4,4°C. Then check the water level in the sight tube. Add or remove water from the tank as necessary to restore the level to "0% Ice".



During normal operation a solid layer of ice at the top of the tank will not form. However, should such a layer be formed due to unforeseen and unwanted operational circumstances, the low level alarm can be activated. In such case melt out the ice completely.

### COIL

The coil should be observed when there is no ice on the coil.

1. Inspect the coil for
  - obstructions
  - damages
  - corrosion
  - fouling



## 2. Remove any obstructions from the coil

Any damages or corroded areas need to be repaired. Call your local BAC representative for assistance.

Regular checking of the total aerobic bacteria count (TAB) and maintaining it within acceptable levels are the key to prevent fouling.

The coil support is a part of the structure of the tank. In case the coils need to be removed, the tank must be emptied.



### CAUTION

**Do not remove or loosen bolts from the coil supports when the tank is filled with water.**

## ICE LOGIC™ ICE QUANTITY CONTROLLER

Check monthly the control sensors for any visual signs of damage.

## GLYCOL

Every six months, or at the seasonal start-up, draw a sample of the glycol solution from the system and check the concentration using a refractometer. If necessary, adjust the concentration using the proper type of industrially inhibited glycol.

Annually, have your glycol supplier check samples of the glycol solution for the proper level of inhibitors and adjust if necessary.



## TSU-M COMPREHENSIVE MAINTENANCE

### About comprehensive maintenance

In order to ensure maximum efficiency and minimum downtime of your evaporative cooling system, it is recommended to establish and execute a programme of preventive maintenance.

Your local BAC representative will assist you in establishing and implementing such programme. The preventive maintenance programme must not only avoid that excessive downtime occurs under unforeseen and unwanted conditions, it also ensures that factory authorized replacement parts are used, which are designed to fit and for their purpose carry the full factory warranty. To order factory authorized parts, contact your local BAC representative. Make sure you include the unit serial number when ordering any parts.

### Prolonged outdoor stay

Should the unit(s) be stored outside prior to installation and/or start-up for approximately one month (shelf life) or longer, or stored in severe climates, it is imperative that certain actions be performed by the installing contractor in order to maintain the unit in "as shipped" condition.

- Check tank. Ice created by subfreezing ambient temperatures, which accumulates at the top of the tank and around the walls must be melted out before initiating a build cycle. This ice can prevent normal water displacement during the build cycle, possibly leading to physical damage to the coil and tank walls. The water temperature in the tank should be raised to 5°C to ensure that all ice is melted.
- Coils of BAC Ice Thermal Storage Units are filled with a low pressure inert gas at the factory before shipping to ensure an optimal internal corrosion protection during transport or prolonged storage. It is recommended to check the overpressure every six months (connect a manometer to the valve).

For complete instructions, please contact your local BAC representative.

## Assistance

BAC has established a specialized total care company called Balticare. The BAC Balticare offering involves all elements required to ensure a safe and efficient operation of your evaporative cooling products.

For more details, contact your local BAC representative for further information and specific assistance at [www.BaltimoreAircoil.eu](http://www.BaltimoreAircoil.eu)

## More information

### REFERENCE LITERATURE

- Eurovent 9-5 (6) Recommended Code of Practice to keep your Cooling System efficient and safe. Eurovent/Cecomaf, 2002, 30p.
- Guide des Bonnes Pratiques, Legionella et Tours Aéroréfrigérantes. Ministères de l'Emploi et de la Solidarité, Ministère de l'Economie des Finances et de l'Industrie, Ministère de l'Environnement, Juin 2001, 54p.
- Voorkom Legionellose. Ministerie van de Vlaamse Gemeenschap. December 2002, 77p.
- Legionnaires' Disease. The Control of Legionella Bacteria in Water Systems. Health & Safety Commission. 2000, 62p.
- Hygienische Anforderungen an raumluftechnische Anlagen. VDI 6022.

### INTERESTING WEBSITES

- [www.BaltimoreAircoil.eu](http://www.BaltimoreAircoil.eu)
- [www.BACservice.eu](http://www.BACservice.eu)
- [www.eurovent-certification.com](http://www.eurovent-certification.com)
- [www.ewgli.org](http://www.ewgli.org)
- [www.ashrae.org](http://www.ashrae.org)
- [www.uniclimate.org](http://www.uniclimate.org)
- [www.aicvf.org](http://www.aicvf.org)
- [www.hse.gov.uk](http://www.hse.gov.uk)

### ORIGINAL DOCUMENTATION



This manual is originally made in English. Translations are provided for your convenience. In the event of discrepancies, the English original text shall prevail over the translation.



A series of horizontal dotted lines for writing, spanning the width of the page.



A series of horizontal dotted lines for writing, spanning the width of the page.







A series of horizontal dotted lines for writing, spanning the width of the page.



A series of horizontal dotted lines for writing, spanning the width of the page.





A series of horizontal dotted lines for writing, spanning the width of the page.

COOLING TOWERS

---

CLOSED CIRCUIT COOLING TOWERS

---

ICE THERMAL STORAGE

---

EVAPORATIVE CONDENSERS

---

HYBRID PRODUCTS

---

PARTS, EQUIPMENTS & SERVICES

BLUE by nature  
GREEN at heart



[www.BaltimoreAircoil.eu](http://www.BaltimoreAircoil.eu)

[info@BaltimoreAircoil.eu](mailto:info@BaltimoreAircoil.eu)

Please refer to our website for local contact details.

Industriepark - Zone A, B-2220 Heist-op-den-Berg, Belgium

© Baltimore Aircoil International nv